

“Combining Price, Performance and Durability”

Ashwoods IPM motor - IPM25(MW)

Motor Features

- Low Cost
- Lightweight
- Compact
- Highly Efficient
- Radial Flux
- Reluctance Torque
- Scalable Design
- EMC Compliant
- Ingress Protection

Specification @ 48V 350A

Peak Power 9kW

Peak Torque 42Nm

Maximum Speed 8500RPM

Peak Efficiency >94%

Weight <6kg

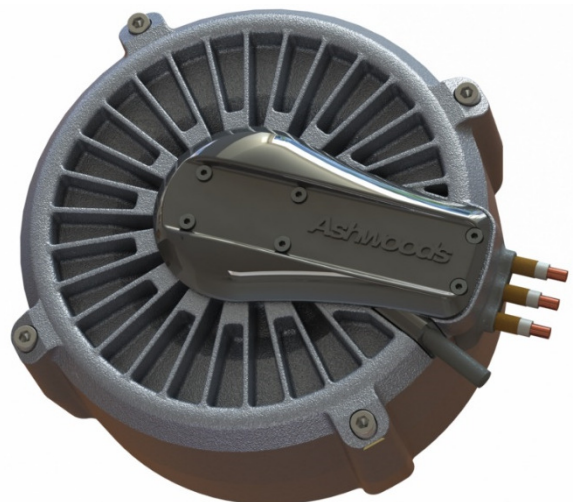
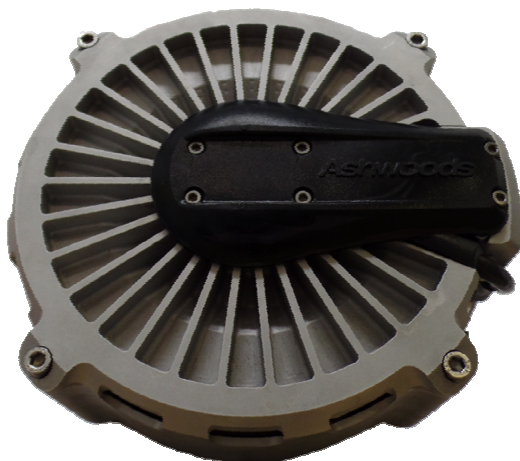
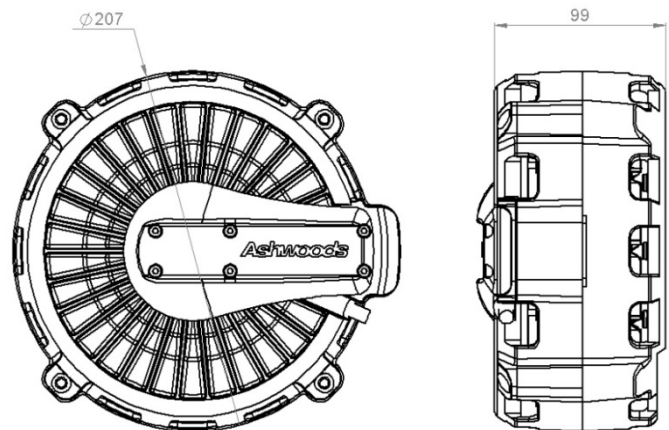

Performance Graphs

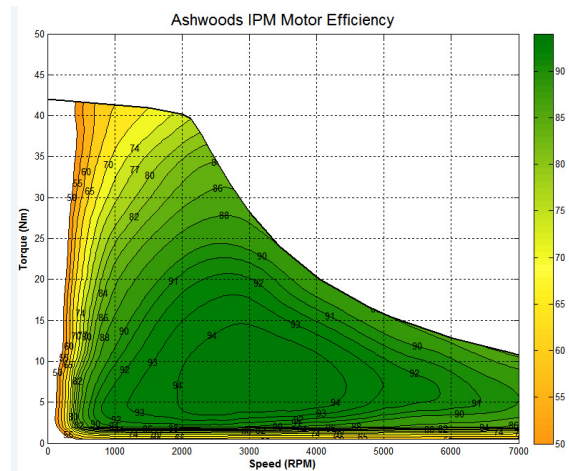
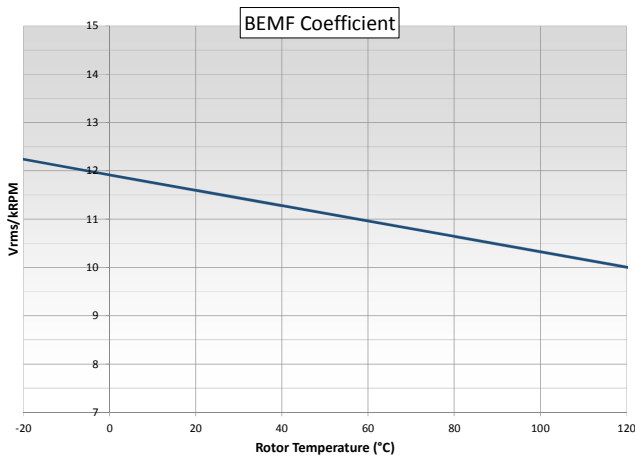
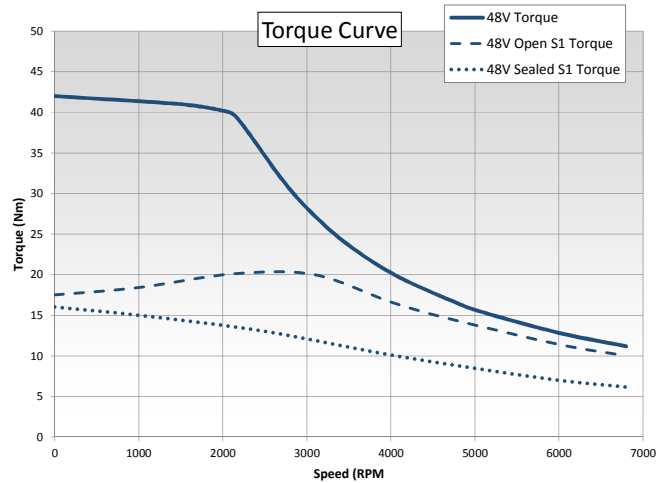
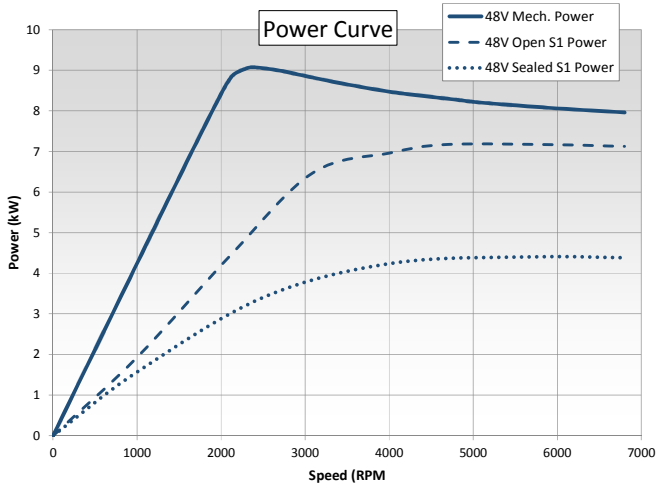

Low Cost & High Performance

- Bringing new innovation to replace old technology without the expense
- Low cost solutions for high power and maximum efficiency
- Experience in volume production and application integration

Compact & Lightweight

- Reduce your application weight
- Increased vehicle range with lighter vehicles
- Easy handling for quick, effective installations
- Reduced shipping and handling costs

Note: The performance ratings stated here are based on typical operating conditions in ambient conditions. Several variables may change the motor performance such as; temperature, inverter settings and parameters, field weakening set-up etc. All specifications are subject to change.